

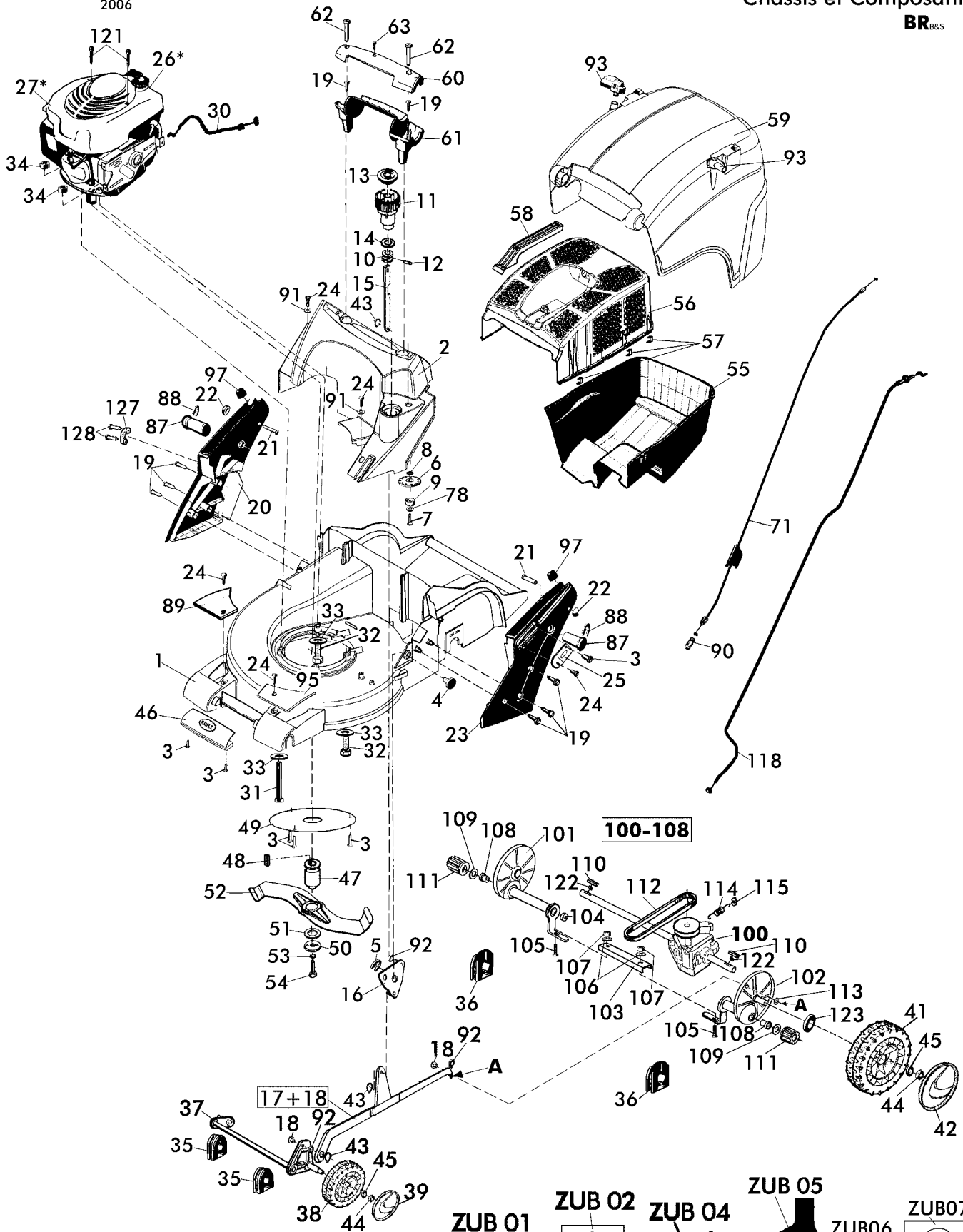







Gehäuse & Anbauteile  
 Chassis & Components  
 Chassis et Composants

**BR**B&S

**BRILL**  
**43 BR ALU-Art.62006**  
 2006



\* = BAUTEILE DES MOTORENHERSTELLERS  
 Parts seek assistance from the engine manufacturer's after sales service

<b>ZUB 01</b> 	<b>ZUB 02</b> 	<b>ZUB 03</b> 	<b>ZUB 04</b> 	<b>ZUB 05</b> 	<b>ZUB 06</b> 	<b>ZUB 07</b> 
--	--	--	--	--	--	--

2/5		BENZIN-SICHELMÄHER m.RADANTRIEB			43 BR ALU- Art.62006
2006		Petrol Lawn mower w. WHEEL DRIVE			
Rev20060407		Tondeuse á gazon a. ALLER-RETOURS			
Bild Nr. REF.N° POS.N°	BEST.-NR. PART-NO. NO d. PIECE	BEZEICHNUNG	DESCRIPTION	Anzahl Qty. Qte.	
1	12960	Gehäuse 43 Al R gep.RAL6001	Chassis 43 BR Al RAL6001	1	
2	13352	Heckblende 43 S	Rear end bezel	1	
3	12723	Schraube DIN7500 NE M5*16-ST-Torx	Screw DIN7500 NE M5*16-ST-Torx	6	
4	13222	Lagerbolzen	Bolt	1	
5	06760	S-SCHEIBE 9 DIN6799-ST VERZ	Circlip 9 DIN6799-ST VERZ	1	
6	10442	SKALENRAD BEDRUCKT	Scale wheel	1	
7	13171	Blechschrabe ISO7049-St 6,3*13-C-	Self-tapping screw 6,3x13	1	
8	08782	O-RING 12,1*2,7 70 SHORE A,	O-Ring 12,1*2,7 70 SHORE A,	1	
9	13170	Lager Skala	Scale bearing	1	
10	08606	VERSTELLBOLZEN	Adjustment bolt	1	
11	13252	VERSTELLKNOPF	Adjustment knob	1	
12	08607	ZYLINDERSTIFT 10H8*22 DIN7-ST VERZ	Parallel pin 10H8*22 DIN7-ST VERZ	1	
13	13169	Deckel bedr.	Cover	1	
14	08610	LAGERSCHEIBE	Disk	2	
15	12942	Zugstange gep RAL7021	Pull rod	1	
16	13463	Schwinge kpl verz.	Rocker	1	
17+18	13466	VERBINDUNGSSTANGE mont.	Con-rod assy.	1	
18	13071	ZUGBOLZEN	Tension bolt	2	
19	13173	SCHRAUBE DIN7500 M6*20 Torx	Screw DIN7500 M6*20 Torx	8	
20	13335	Holmknoten rts RAL7045	Bar joint right RAL7045	1	
21	13796	Bolzen	Bolt	2	
22	13198	Sperrkappe 6 SBK 1863 vern.	Arrestor cap	2	
23	13336	Holmknoten lks RAL 7045	Bar joint left RAL7045	1	
24	13232	SCHRAUBE DIN7500 M5*12 Torx verz	Screw DIN7500 M5*12 Torx verz	5	
25	13209	Bowdenzughalter	Cable connector	1	
26	13255	V-Motor B&S QUANTUM X55	V-Motor B&S QUANTUM X55	1	
27	13569	Motorhaube XRM 55 RA	Motor cover XRM 55 RA	1	
30	13834	Bowdenzug Bremse B&S X55 kurz	Brake cable B&S X55 short	1	
31	13800	SKT-Schraube M8*110 DIN 931	Hex.Hd.Screw M8x110 DIN 931	1	
32	13799	SKT-Schraube M8x80 DIN 931-8.8 verz	Hex.Hd.Screw M8x80 DIN 931-8.8	2	
33	07500	SCHEIBE A8,4*25*3 AEHNL,DIN902	Washer	3	
34	08427	SPERRZAHNMUTTER M8,KL,8	Special nut M8	3	
35	12944	Lagerschale vorn	Front Bearing Seat	2	
36	09045	LAGERSCHALE HINTEN RAL9005	Rear Bearing seat	2	
37	12945	Vorderachse kpl gepulv.RAL7021	Front axle assy.	1	
38	12946	Laufgrad 172 kpl m.Kugellager	Wheel 172 assy.w.ball bearing	2	
39	12947	Radkappe 172 Silencio	Wheel cap 172 Silencio	2	
41	13540	Antriebsrad 195 kpl m.Kugellager	Wheel 195 Assy. W.ball bearing	2	
42	12952	Radkappe 195 Silencio	Wheel cap 195 Silencio	2	
43	10574	S-SCHEIBE 6 DIN6799 ROH	Circlip 6	4	
44	06684	SKT-MUTTER M 8 DIN985-8 VERZ	Hex.Hd.Nut M8	4	
45	06465	SCHEIBE A8,4 DIN125-ST VERZ	Washer	4	
46	12961	Griffschale vorn gepulvert	Grip jacket	1	
47	15116	Messerflansch Antrieb verz.	Blade flange BS Self-Drive	1	
48	02713	KEIL WOODRUFF505 5/32*51	Woodruff Key	1	
49	13450	ABDECKSCHEIBE GEP RAL7021	Barrier	1	
50	08654	SPANNSCHEIBE GEP RAL2002	Tension Screw	1	
51	08740	REIBSCHEIBE , MIT WERKSBES,DIN	Friction disk	1	
52	13968	Messer 43 gep.	Duo-Cutting Blade 43	1	
53	06460	SCHEIBE A10,5 DIN125-ST VERZ	Washer	1	
54	13313	SKT-SCHRAUBE 3/8"24UNF 2 "-8,8	Tension Screw 3/8"24UNF 2 "-8,8	1	
55	13735	Fangkorb UT	Lower Grass Catcher 43	1	
56	13734	Fangkorb OT	Upper Grass Catcher 43	1	

3/5		BENZIN-SICHELMÄHER m.RADANTRIEB			43 BR ALU- Art.62006
2006		Petrol Lawn mower w. WHEEL DRIVE			
Rev20060407		Tondeuse á gazon a. ALLER-RETOURS			
Bild Nr. REF.N° POS.N°	BEST.-NR. PART-NO. NO d. PIECE	BEZEICHNUNG	DESCRIPTION	Anzahl Qty. Qte.	
57	12970	Verbindungsclammer FK Silencio	Clamp	7	
58	08252	TRAGEGRIFF ROT, LOSE	Grip	1	
59	12967	Multi-Funktions-Box RAL6001	Crass Box Cover	1	
60	12965	Heckgriff OT gepulvert silber	Rear grip, Upper part	1	
61	12963	Heckgriff UT gepulvert silber	Rear grip, Lower part	1	
62	13231	SCHRAUBE M6*40 DIN7500 Torx,verz.	Screw	2	
63	13230	SCHRAUBE M4*20 DIN7500 Torx,verz.	Screw	1	
71	12999	Bowdenzug Bremse Holm	Upper Brake Cable 1	1	
78	06843	SCHEIBE A5,3 DIN9021 VERZ	Washer	2	
87	13460	Gelenkbolzen	Joint bolt	2	
88	13156	S-Scheibe DIN6799-19-SnBz8	Circlip	2	
89	13182	Abdeckung rts.	Cover right	1	
90	13248	Bowdenzugverbinder	Cable connector	1	
91	06843	SCHEIBE B5,3 DIN9021 VERZ	Washer	2	
92	08399	FESCH B8,4*15*0,2 DIN137 VERZ	Serrated washer	3	
93	12996	Mitnehmer	Tappet	2	
94	13446	LIB-Schraube ISO 7049-4,8*12	Screw ISO 7049-4,8x12	2	
95	13175	Abdeckung rts.	Cover right	1	
96	13900	Torx-Schraube M5x12 DIN 7500 lack	Torx-screw Din 7500-M5x12	2	
97	11519	Gummifuss schwarz	Rubber pad black	2	
100-108	13786	Antrieb 41/43 komplett	Drive propulsion system assy. 41/43	1	
100	13787	Getriebe komplett	Gear box assy.	1	
101	13801	Hüllrohr lang kpl. 41/43	Cladding tube long assy. 41/43	1	
102	13789	Hüllrohr kurz kpl.	Cladding tube short assy. 41/43	1	
103	13806	Verbindungsflasche 43	Connection bracket 43	1	
104	13807	Hülse 43 verz.	Spacer 43 vz.	1	
105	06642	Schraube DIN 933-6x20	Screw DIN 933-6x20	2	
106	06464	Scheibe DIN 125-A6,4	Washer A6,4	2	
107	11049	SKT-Mutter DIN 985-M6	Hex.hd.Nut DIN 985-M6	2	
108	13066	Lagerbuchse	Bearing bush	2	
109	00930	Anlaufscheibe	Waher	2	
110	13792	Sperrkeil	Ratchet key	2	
111	13788	Sperrzahnrad rechts & links	Ratchet wheel left & right	2	
112	13793	Keilriemen	V-belt	1	
113	09674	Scheibe A7,4	Washer	1	
114	13943	Zugfeder z. Getriebe	Tension spring	1	
115	13424	Scheibe z. Zugfeder	Special washer for tension spring	1	
118	13519	Bowdenzug Kupplung	bowden cable (Wheel drive)	1	
121	13935	Schraube zum Motor 4,3*31	Screw 4,3*31	2	
122	13794	Feder zum Sperrkeil	Spring for ratchet key	2	
123	14277	Scheibe DIN 125-A15	Washer DIN 125-A15	2	
127	13922	Kabelklemme	Clamp	1	
128	13444	LIB-Schraube ISO7049-St 4,8*19-C-Torx-	Screw ISO7049-St 4,8*19-C-Torx	2	
ZUBEHOER		ACCESSORIES			
ZUB01	13350	GEBRAUCHSANWEISUNG Brillencio	Instruction for use Brillencio	1	
ZUB02	00563	KUNDENDIENSTVERZEICHNIS	Brill-Service-Booklet	1	
ZUB03	06574	STECKSCHLÜSSEL DIN659 SW19/21	Box spanner SW 19/21	1	
ZUB04	06591	DREHSTIFT 5x100 DIN900 VERZ	Pin 5x100	1	
ZUB05	76012	4-Takt-Motorenöl Flasche (optional)	Four stroke engine oil bottle (optional)	1	
ZUB06	13778	Geräteaufkleber "Kippen"	Label "tipping"	1	
ZUB07	14997	GAW Ergänzung 62006	Instruction added information 62006	1	



zum RADANTRIEB  
for Wheel drive  
pur Entraînement à roues

Gestänge,  
Handle Bar,  
Manche

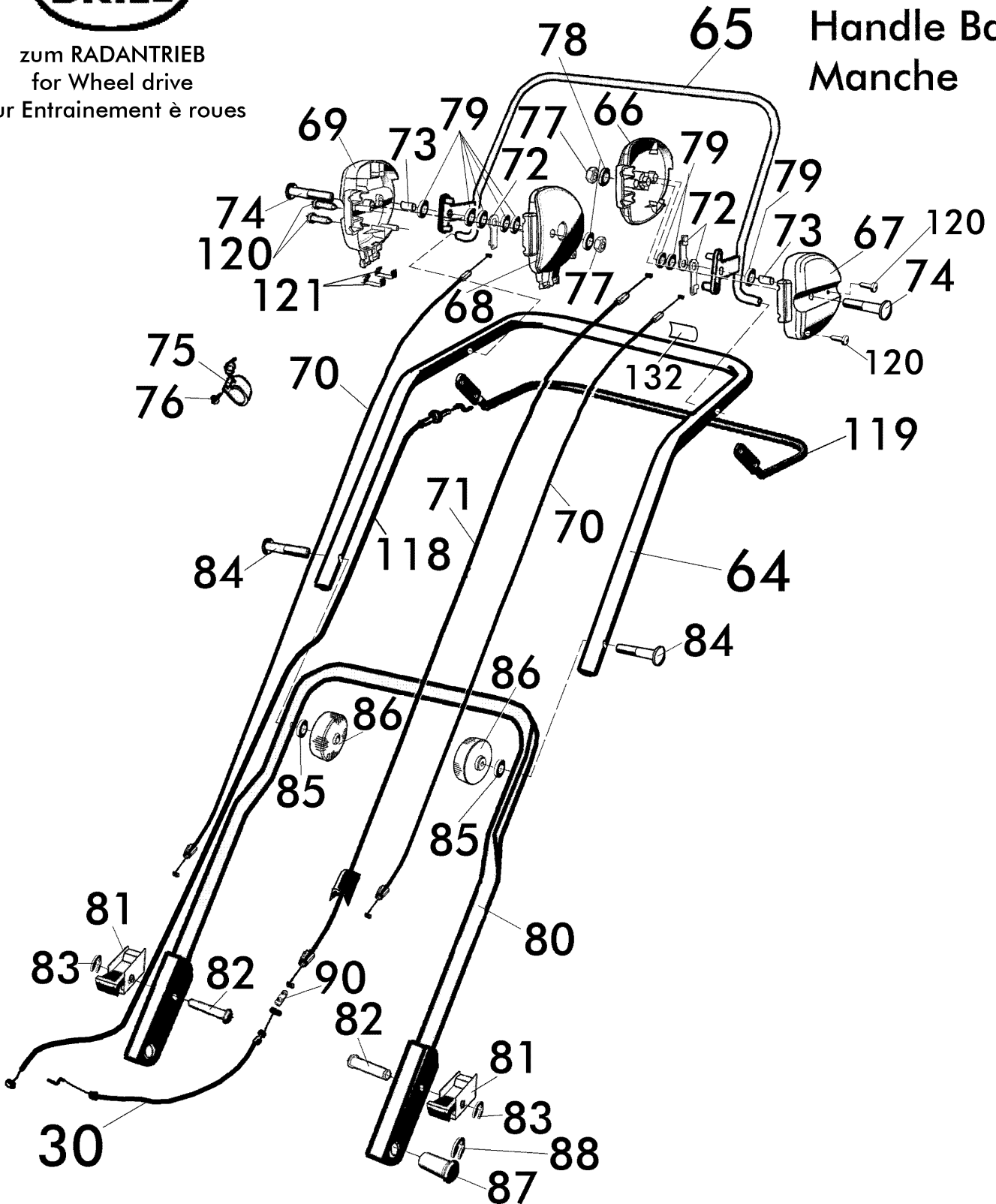

5/5		BENZIN-SICHELMÄHER m.RADANTRIEB			43 BR ALU- Art.62006
2006		Petrol Lawn mower w. WHEEL DRIVE			
Rev20060407		Tondeuse á gazon a. ALLER-RETOURS			
Bild Nr. REF.N° POS.N°	BEST.-NR. PART-NO. NO d. PIECE	BEZEICHNUNG	DESCRIPTION	Anzahl Qty. Qte.	
30	13834	Bowdenzug Bremse B&S X55 kurz	Brake cable B&S X55 short	1	
64	13141	GESTÄNGE-OBERTEIL	Upper handle bar	1	
65	13000	Bremsbügel kpl gep.RAL2002	Brake bail assy.	1	
66	13229	Holmgehäuse lks innen bedruckt	Bar housing left inboard	1	
67	13228	Holm-Gehäuse lks außen	Bar housing left ambient	1	
68	13226	Holm-Gehäuse rts innen	Bar housing right inboard	1	
69	13227	Holm-Gehäuse rts außen	Bar housing right ambient	1	
70	12998	Bowdenzug-Entriegelung	Cable lock-out release	2	
71	12999	Bowdenzug Bremse Holm	Upper Brake Cable 1	1	
72	13150	Bowdenzugmitnehmer	Cable tappet	3	
73	13151	ZYLINDERSTIFT ISO2338-B-8*24-St	Pin ISO2338-B-8*24-St*-verz	2	
74	13254	Fru-SCHRAUBE M6*50 DIN 603 verz	Screw	2	
75	10953	UMLENKHALTER	Cable guide	1	
76	08722	LIB-SCHRAUBE BZ 3,5*13 DIN7981 V2A	Screw	1	
77	06683	SKT-MUTTER M6 DIN985 VERZ	Hex.Hd.Nut M6	2	
78	06464	Scheibe DIN 125-A6,4	Washer A6,4	2	
79	06465	SCHEIBE A8,4 DIN125-ST VERZ	Washer	2	
80	12979	GESTÄNGE-UNTERTEIL gep.RAL7021	Lower handle bar	1	
81	13510	Sperrklinke mont.	Catch Assy.	2	
82	13140	Bolzen	Bolt	2	
83	06755	S-SCHEIBE 5 DIN6799 VERZ	Circlip 5	2	
84	09191	FORMSCHRAUBE M8*47 N ZG	Special form screw	2	
85	06465	SCHEIBE A8,4 DIN125-ST VERZ	Washer	2	
86	13294	Holm-Spanngriff	bar tension grip	2	
87	13460	Gelenkbolzen	Joint bolt	2	
88	13156	S-Scheibe DIN6799-19-SnBz8	Circlip	2	
90	13248	Bowdenzugverbinder	Cable connector	1	
118	13519	Bowdenzug Kupplung	Bowden cable (Wheel drive)	1	
119	13234	Kupplungsbügel RAL 2002	Wheel drive bracket RAL2002	1	
120	12032	ZK-Schraube 3,5x20	ZK-screw 3,5x20	4	
121	12970	Verbindungsklammer FK Silencio	Clamp	2	
132	12677	Aufkleber Bedienung weiß	Label Using white	1	